

Operational Notes on Non-Directional Beacons (NDB) and Associated Automatic Direction Finding (ADF)

Contents

Disclaimer

These notes are a reproduction of a booklet originally published by the Civil Aviation Authority. Although these notes are no longer in print, they continue to provide a valuable resource and are made available as reference material for students, pilots and instructors. The notes have not been edited, and as they were written 20 or more years ago, may contain information relating to systems that are no longer in production or have been modernised.

1.	Introduction	1-1
2.	NDB (Ground Station)	2-1
2.1	Transmitter.....	2-1
2.2	Monitoring	2-2
3.	Radio Compass Receiver	3-1
4.	Limitations of the NDB/ADF	4-1
4.1	Night Effect	4-1
4.2	Co-Channel and Adjacent Interference from Other NDBs	4-3
4.3	Mountain Effect	4-4
4.4	Thunderstorms.....	4-5
4.5	The Effect of Terrain	4-6
4.6	Height Effects.....	4-7
4.7	Most Appropriate NDB	4-8
5.	Operational Use of the Radio Compass.....	5-1
5.1	Aural Null	5-1
5.2	Time and Distance	5-2
5.3	Compass Bearings.....	5-3
5.4	‘Homing’ and Tracking Towards or Away from an NDB	5-4
5.5	Intercepting a Given Track.....	5-7

Operational Notes on Non-Directional Beacons (NDB) and Associated Automatic Direction Finding (ADF)

1. Introduction

The non-directional beacon and its associated automatic direction finding equipment is primarily a short distance navigational aid. The ground station (NDB) radiates a signal in all directions around the transmitter, and the aircraft receiver (ADF), when tuned to this signal determines the direction from which the signal is being radiated. By following the direction indicated by the ADF instrument the aircraft will fly over the NDB.

The system operates in the medium frequency band, that is, 200 to 400 Kcs., however, most aircraft equipments are sufficiently flexible to enable one or two additional bands to be selected so as to extend the use of this facility to cover bands utilised by broadcasting stations. In isolated cases NDBs are operated in the higher frequency band (1666 Kcs.) to lessen the reflecting influence of mountainous country.

■

Operational Notes on Non-Directional Beacons (NDB) and Associated Automatic Direction Finding (ADF)

2. NDB (Ground Station)

2.1 Transmitter

The NDB is basically a simple transmitter radiating an omnidirectional signal which is modulated at intervals with the identification code. The basic signal is known as a carrier and is radiated at the frequency specified for the particular aid. The identification code is a 400 or 1020 cycle note superimposed on the carrier. Some installations include voice modulation to provide landing information and some others, for remote monitoring purposes, have one or two pips between idents.

NDBs may be sited in association with ILS, or in some cases two NDBs are sited to provide an instrument approach to landing. NDBs so used are known as locator beacons. There is no fundamental difference between an NDB and a locator beacon but, generally speaking, a locator beacon operates on a lower power. In this publication, the term NDB includes locator beacon.

Most NDBs are installed in pairs, that is, main and standby. Of recent date low power transistorised NDBs are being installed to provide navigational assistance over limited distances. These installations are single equipments.

Except for transistorised NDBs, which have a transmitter power of 15 watts, the power of NDBs range from 100 watts to 3 kilowatts. Locator beacons are usually in the 100 watt class while the 3 k.w. beacons are sited to provide assistance to major overwater crossings, that is, Darwin, Sydney, Perth. The majority of other NDBs are in the 100–500 watt category.



Operational Notes on Non-Directional Beacons (NDB) and Associated Automatic Direction Finding (ADF)

2. NDB (Ground Station)

2.2 Monitoring

NDBs have automatic monitoring of certain parameters which cause the NDB to be turned off if outside tolerance and the standby activated. If the same out-of-tolerance condition is also present on the standby transmitter, the complete installation is deactivated until the fault is rectified. Faults which are automatically monitored include:

- Excessive hum level
- Reduction of carrier power
- Failure or reduction in level of identification code.

Further monitoring is arranged to ensure the installation is radiating either by a monitoring post at a manned aerodrome within range of the NDB or by pilot monitoring where NDBs are sited in remote areas. In the latter case pilots should report the failure of an NDB to the appropriate communications station so that action may be taken to rectify the fault.



Operational Notes on Non-Directional Beacons (NDB) and Associated Automatic Direction Finding (ADF)

3. Radio Compass Receiver

The basis for operation of all radio compasses is that the maximum signal will be received when a loop antenna is aligned in the direction of the radiated signal. The corollary is that a minimum signal, or null, occurs when the loop antenna is at right angles to the direction of the radiated signal. In practice, however, the position of minimum signal is used because it can be more accurately determined than a maximum. Appropriate compensation is made to the indicator drive to allow for this 90 degree shift.

Early model radio compasses used this principle to advantage by manually rotating the loop to determine an 'aural null'. The bearing was then determined from a simple indicator and bearing card, ambiguity having been solved by procedural means. (See *Operational Use of the Radio Compass*.) Later equipments introduced the automatic phase but also retained the aural null facility as a standby in the event of failure of the automatic circuitry. Some manufacturers of present day equipment are dispensing entirely with the aural null facility.

The principal components of the Automatic Direction Finding (ADF) equipment consist of the receiver, loop antenna, loop drive motor, fixed antenna, control box and indicator.

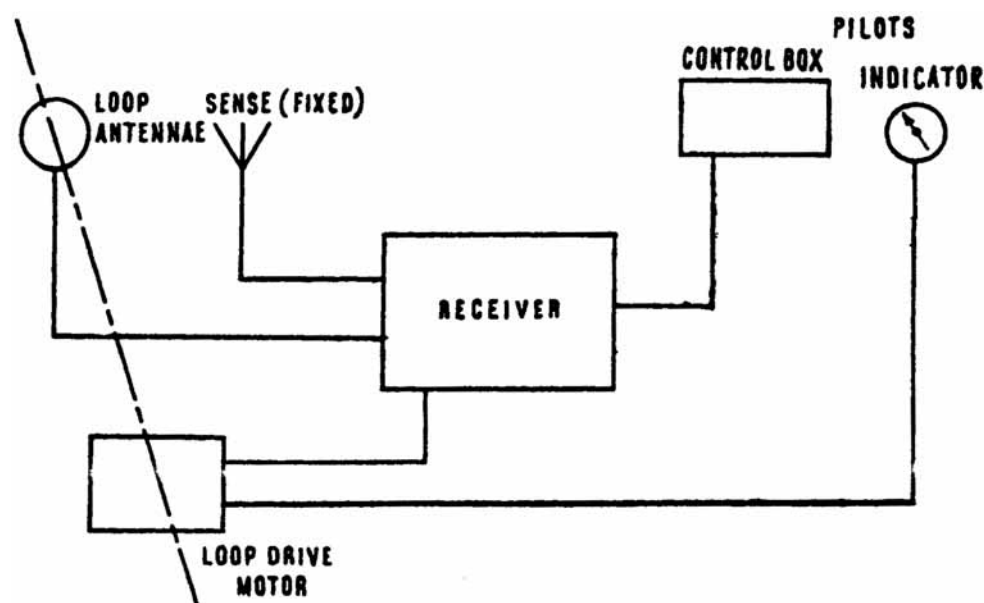

Figure 1. Automatic Direction Finding (ADF) Equipment

When a station is tuned the signal is received at both the fixed and loop antennae. The signals received from the loop antenna are fed from the ADF receiver into the loop drive motor, and this aligns in the direction of the received signal, that is, it points to the signal null.



Operational Notes on Non-Directional Beacons (NDB) and Associated Automatic Direction Finding (ADF)

3. Radio Compass Receiver

Because of its physical shape and, consequently, directional properties, a loop can assume two positions and receive two signal nulls, one 180 degrees removed from the other. To resolve this ambiguity the signal received from the sense antenna (a signal independent of direction) is mixed with signals from the loop antenna and combines in such a way so as to orientate the loop in the correct direction. The rotation of the loop is electrically coupled to the pointer of the indicator, thus when the loop is receiving a null the indicator always shows the pilot the direction of the transmitting station to which he has tuned.

Some later ADF equipments do not have a rotatable loop; the loop aerial is fixed, and a goniometer is made to rotate within the receiver. The end result is, however, the same.

The method of presenting ADF information to the pilot takes many forms—from a simple card and needle indicator, to the latest types of sophisticated integrated flight systems. The most common types in use however are the fixed card (0 to 360 degrees) with centrally pivoted needle, and the Radio Magnetic Indicator (RMI). The needle in the fixed card type indicates the direction of the signal *relative* to the heading of the aircraft (0 degrees on the fixed card is the aircraft longitudinal axis) and the received signal direction must be relative to this axis, or aircraft heading. The *actual* bearing of the signal can only be assessed by adding the relative bearing to the aircraft heading. The RMI was developed to remove the necessity of adding the relative bearing to the aircraft heading. This was accomplished by simply slaving the indicator card to a magnetic compass by electrical means, hence both the card and the needle are free to rotate in an RMI. The card will rotate in sympathy with any changes in aircraft heading and the needle will always point in the direction of the radiated signal. The actual bearing of the NDB is directly available from the compass card below the ADF needle.

Because of the variety of equipments available it is not practical to specify here any one tuning technique. However, it is vitally important when using the radio compass receiver that it be correctly tuned to the frequency of the required station in accordance with the techniques specified either in the manufacturer's instruction book or the operator's operations manual, and especially with newer types of compasses which require precise tuning to be effected by aural means instead of the previously used visual tuning meter method. Tuning techniques cannot be given in this publication as the methods to be used differ, not only from one type of receiver to another, but also in relation to a particular receiver owing to variations in ancillary equipment in different installations. Examples of this are the 1020 cycles per second **range** filter which usually forms part of the selector box and the mechanical or crystal filters which may be fitted within the receiver for **sharp** tuning purposes.

Note: Receivers fitted with 'voice' and 'ident' filters must have 'voice' selected to receive 400 cps idents.



Operational Notes on Non-Directional Beacons (NDB) and Associated Automatic Direction Finding (ADF)

3. Radio Compass Receiver

If a radio compass receiver is not tuned in accordance with the manufacturer's prescribed method its efficiency will be affected. Faulty tuning may result in:

- Incorrect bearing indication (produced electrically)
 - Increased adjoining channel interference
 - Incorrect bearings when the atmospheric interference level is high
 - Reversed sense indications
 - Restricted service range.
-

Operational Notes on Non-Directional Beacons (NDB) and Associated Automatic Direction Finding (ADF)

4. Limitations of the NDB/ADF

4.1 Night Effect

Radio waves take two paths to the radio compass receiver. The first and normal path is along the earth's surface. If only these waves were received, the compass would point directly to the NDB. The second path is via one or more wave refracting layers above the earth (the ionosphere) returning to earth to mix with direct waves. Complete changes in the nature of the waves take place on this path and produce errors in direction.

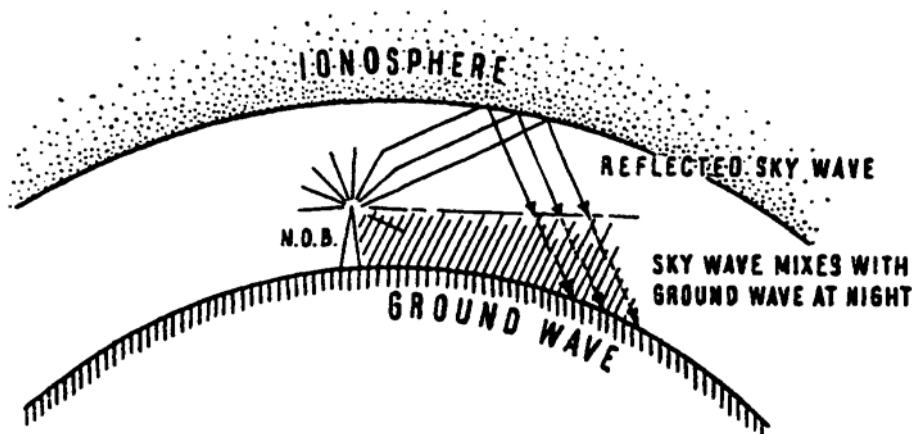

Figure 2. The night effect

The ratio of the intensity of indirect to direct waves in the total received signal determines the liability of error of the radio compass. As the strength of the indirect waves is far greater at night, errors then are more common and of greater magnitude: this is called 'night effect'. Often this effect is more pronounced within an hour of sunrise or sunset, when the changes in the state of ionisation of the upper atmosphere are particularly violent.

The night time range of an NDB is only dependable over distances where the ground wave transmission predominates, which is approximately 60 miles over land and 100 miles over sea under reasonable propagating conditions. As the distance increases the ratio of indirect to direct waves will increase and bearing indications will become erratic. Treat with caution NDB reception beyond these ranges.

With the exception of the very low-powered beacons the useful range is virtually independent of the power of the transmitter: increased power increases the strength of the ground and sky waves by the same amount. The ratio of indirect to direct waves therefore remains the same.

In the case of the locator beacons the low power restricts transmission to ground wave only and the range therefore seldom exceeds 30 miles day or night. Consequently these beacons are virtually unaffected by night effect.



Operational Notes on Non-Directional Beacons (NDB) and Associated Automatic Direction Finding (ADF)

4. Limitations of the NDB/ADF

4.1 Night Effect

It is essential to know when night effect is present and to thoroughly understand its effect upon the performance of the equipment because these errors are not only common but are impossible to correct.



Operational Notes on Non-Directional Beacons (NDB) and Associated Automatic Direction Finding (ADF)

4. Limitations of the NDB/ADF

4.2 Co-Channel and Adjacent Interference from Other NDBs

If the signal from another NDB operating on the same or an adjacent frequency is received with sufficient strength, the automatic bearing determination circuits of the compass receiver will be influenced and a bearing error will result. Generally NDBs are spaced geographically, and frequencies allocated to minimise these effects. At night, however, when the sky wave component of an NDB extends to a far greater distance than that of its ground wave, it may cause interference. This may be serious if the ADF receiver is tuned to an NDB beyond its rated coverage, when the signal strength will be low and therefore susceptible to interference from extraneous transmissions.

It is important to appreciate that the audible perception of another NDB identification code heard on the same frequency as the selected NDB does not necessarily mean that the indicated bearing is in error. Although its identification code can be heard, the interfering signal may not be strong enough to influence the directional properties of the ADF receiver. Under these circumstances, however, the indicated bearing should be considered suspect and checked by other means.



Operational Notes on Non-Directional Beacons (NDB) and Associated Automatic Direction Finding (ADF)

4. Limitations of the NDB/ADF

4.3 Mountain Effect

Sometimes an effect similar to night effect is obtained in mountainous areas where the energy received from an NDB consists of two or more waves, one of them direct and others by reflection from the mountains. Bearing indications are found to change rapidly until the affected area is passed.



Operational Notes on Non-Directional Beacons (NDB) and Associated Automatic Direction Finding (ADF)

4. Limitations of the NDB/ADF

4.4 Thunderstorms

A thunderstorm generates a tremendous amount of radio frequency energy and when the aircraft is near to a storm centre the radio compass may indicate the direction of the storm and not that of the NDB to which it is tuned. Therefore, when flying in the vicinity of a thunderstorm, the accuracy of the bearing indications should be checked by other means whenever possible.



Operational Notes on Non-Directional Beacons (NDB) and Associated Automatic Direction Finding (ADF)

4. Limitations of the NDB/ADF

4.5 The Effect of Terrain

The useful range of an NDB is influenced by the type of terrain over which the radio wave travels. It is greatest over the sea and least over sandy or mountainous country, and an NDB with a daylight range of 600 miles over the sea may only have a range of little more than 100 miles over unfavourable types of land. Therefore, when an NDB is located on the coastline, its range in different directions can be expected to vary considerably.



Operational Notes on Non-Directional Beacons (NDB) and Associated Automatic Direction Finding (ADF)

4. Limitations of the NDB/ADF

4.6 Height Effects

The range of an NDB over the sea is relatively independent of aircraft height. Over unfavourable terrain it increases considerably with height.



Operational Notes on Non-Directional Beacons (NDB) and Associated Automatic Direction Finding (ADF)

4. Limitations of the NDB/ADF

4.7 Most Appropriate NDB

When overflying an NDB make use of backtracking procedures. A back bearing is far superior to one obtained by tuning a more distant NDB. The navigational tolerance for the route is based on assistance from the closest NDB, therefore, select the NDB ahead when approximately half way.

When selecting an NDB at a terminal for either an arrival or departure this NDB must be in accordance with the flight planned route. Although the airport NDB will give greatest coverage, in some cases the flight planned route may be predicated on a locator beacon, due to separation requirements and must be selected accordingly.



Operational Notes on Non-Directional Beacons (NDB) and Associated Automatic Direction Finding (ADF)

5. Operational Use of the Radio Compass

5.1 Aural Null

In order to determine a bearing by using only the aural null facility the desired NDB is accurately tuned as specified by the manufacturer and the tone produced is most receptive to the human ear, usually about 1000 cycles. The loop is then rotated until a null is determined and the associated indicated bearing will provide a position line relative to the heading of the aircraft. If the loop is made to rotate a further 180 degrees, a second null would be evident: either indicated bearing of these two nulls would determine the same position line. In order to sense the direction the NDB bears from the aircraft, a procedure must be flown.

The aircraft is turned until the null shifts to a position in line with the wing tips, that is, at right angles to the aircraft heading. The aircraft is then maintained on this heading and the null continually checked until the bearing has changed some ten degrees.

Whenever an aircraft is flown on a heading at right angles to the bearing of an NDB the NDB recedes behind the aircraft; therefore an indicated bearing which shifts towards the tail of the aircraft is the correct bearing, and a bearing which shifts towards the nose of the aircraft is the reciprocal. If the indicator is a simple fixed card type the bearing indicated is a relative bearing (relative to the aircraft's heading).

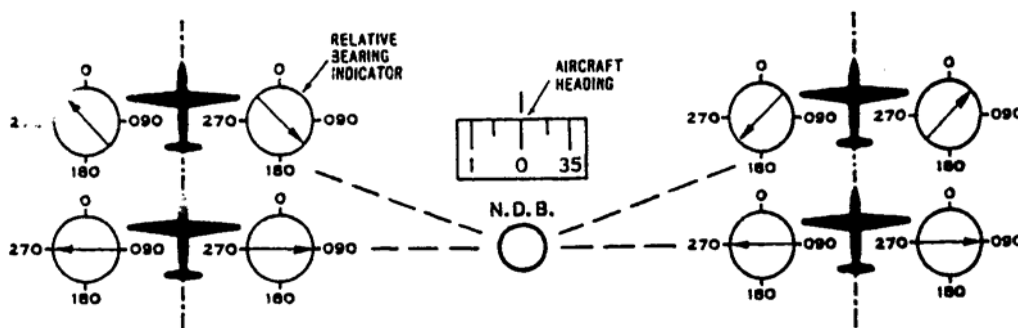

Figure 3: Resolving Ambiguity Using Aural Null Procedure

Having resolved ambiguity, the aural null may be used to track towards or away from the NDB, or to intercept a given track. Procedures for these manoeuvres are precisely the same as those detailed for use when the ADF is operative, with the exception of the following additional procedure to determine the passage over an NDB:

When using the aural null, approximately three minutes before ETA, rotate the loop 90 degrees to receive a maximum signal, then reduce the receiver volume. If the correct heading is maintained, passage over the NDB will be detected by an increase in volume, immediately followed by a 'cone of silence' prior to a second increase: the 'cone of silence' is directly above the NDB.

Operational Notes on Non-Directional Beacons (NDB) and Associated Automatic Direction Finding (ADF)

5. Operational Use of the Radio Compass

5.2 Time and Distance

When resolving ambiguity of direction by the aural null procedure, outlined above, the time taken for the null to change through any number of degrees may be noted and used to ascertain the distance from the NDB and the time to fly to the NDB. The following simple formula may apply equally well to a change in bearing determined by the ADF:

$$(i) \frac{\text{Minutes flown x ground speed}}{\text{Degrees of bearing change}} = \text{Miles to NDB}$$

$$(ii) \frac{\text{Minutes flown x 60}}{\text{Degrees of bearing change}} = \text{Minutes to fly to NDB}$$

A convenient means of mentally applying formula (ii) is to time 10 degree change; then:

$$\frac{\text{Time in seconds}}{10} = \text{Time in minutes to NDB}$$

This formula is only an approximation in conditions other than zero wind.



Operational Notes on Non-Directional Beacons (NDB) and Associated Automatic Direction Finding (ADF)

5. Operational Use of the Radio Compass

5.3 Compass Bearings

To calculate a compass bearing the aircraft compass heading must be added to the relative bearing. With an RMI this compass bearing is read directly from the slaved card. Conversion of a compass bearing to a magnetic bearing is achieved by applying the compass deviation applicable to the particular heading. If it is desired to plot the position line on a map a true bearing must be calculated by applying the appropriate magnetic variation.



Operational Notes on Non-Directional Beacons (NDB) and Associated Automatic Direction Finding (ADF)

5. Operational Use of the Radio Compass

5.4 'Homing' and Tracking Towards or Away from an NDB

An aircraft may be flown to an NDB ('homed') by simply selecting a heading whereby the ADF indicator shows the NDB to be directly ahead. By maintaining the ADF needle on 0 degrees, or in the case of an RMI on the heading datum, the aircraft will fly over the NDB to which the radio compass has been tuned. A constant heading or track will, however, only be possible in conditions of zero wind, or a direct head wind or tail wind. If drift is present and has not been allowed for, it will be necessary to constantly change the aircraft heading in order to maintain the ADF on 0 degrees, and consequently the final track towards the NDB will be upwind. To avoid this, and maintain a constant track, allowance must be made for drift and applied to the initial heading before commencing tracking to the station.

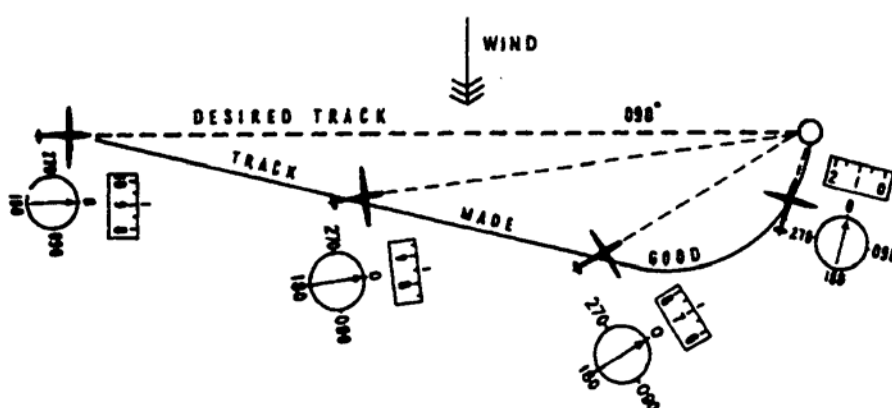

Figure 4: 'Homing'

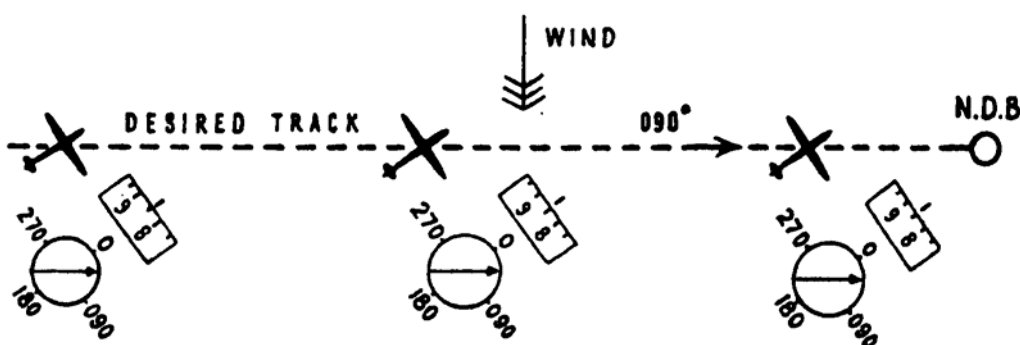

Figure 5: Tracking (that is, Allowance for Drift)

When departing from an NDB, three procedures are possible. Each of these is described and illustrated below.



Operational Notes on Non-Directional Beacons (NDB) and Associated Automatic Direction Finding (ADF)

5. Operational Use of the Radio Compass

5.4 'Homing' and Tracking Towards or Away from an NDB

One procedure is to maintain the relative indicator bearing on 180°. However, if drift is present, maintaining 180° on the ADF results in increasing deviation from the desired track, as shown in the diagram.

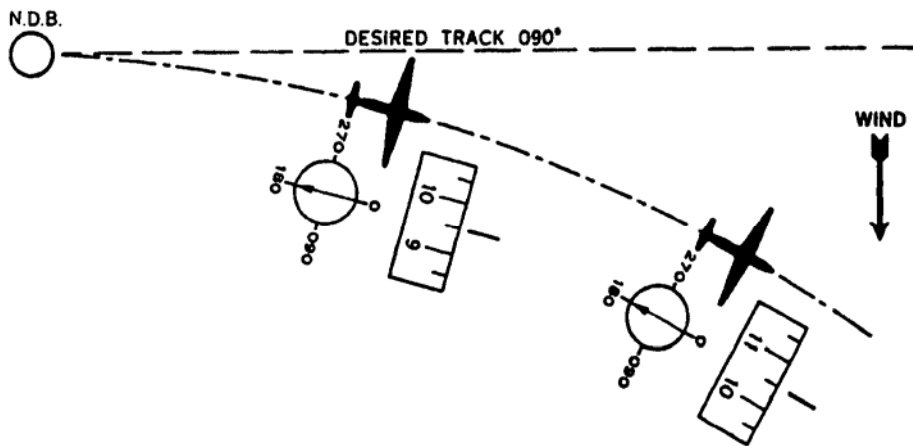

Figure 6: Departing (Maintaining 180° on ADF)

Another procedure is for the aircraft to maintain the same heading as the desired track. Again, however, if drift is present, the aircraft will deviate from the desired track, the ADF relative bearing indicator remaining constant on a reading consistent with the amount of drift.

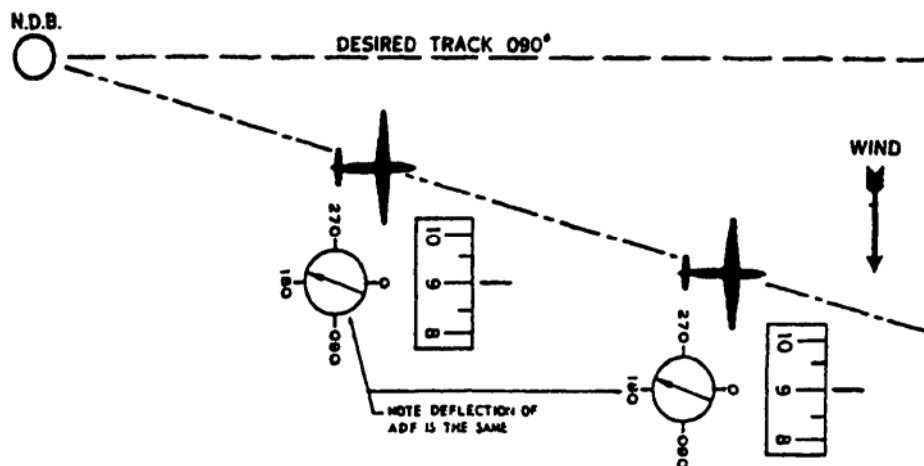

Figure 7: Departing (Maintaining Heading on Aircraft Magnetic Compass)



Operational Notes on Non-Directional Beacons (NDB) and Associated Automatic Direction Finding (ADF)

5. Operational Use of the Radio Compass

5.4 'Homing' and Tracking Towards or Away from an NDB

The correct procedure is to backtrack, applying drift to the aircraft heading. In this case the ADF relative bearing indicator will show a constant reading (assuming drift remains constant) varying from 180° by the difference between the aircraft heading and the desired track.



Figure 8: Backtracking (that is, Allowance for Drift)

Operational Notes on Non-Directional Beacons (NDB) and Associated Automatic Direction Finding (ADF)

5. Operational Use of the Radio Compass

5.5 Intercepting a Given Track

When it is required to track towards an NDB on a given track it will first be necessary to establish the aircraft on this track. Before adopting any procedure to accomplish this, it is most important that the pilot establish a mental picture of his present position in relation to the NDB and this track. An initial step which is most helpful is to turn the aircraft onto a heading which is the same bearing as that of the given track. The relative bearing of the NDB is then noted and the aircraft turned towards the given track on a heading to intercept it at a predetermined angle. When the interception heading has been decided, this heading should be flown until the ADF indicator shows a bearing on the appropriate side of the nose datum, which is to the difference between the aircraft heading and the given track. When track is established due allowance must be made for drift in order to maintain a constant track.

The same principles apply when intercepting a track away from an NDB. In this case calculations are relative to the tail of the aircraft, or 180 degrees on the ADF indicator.

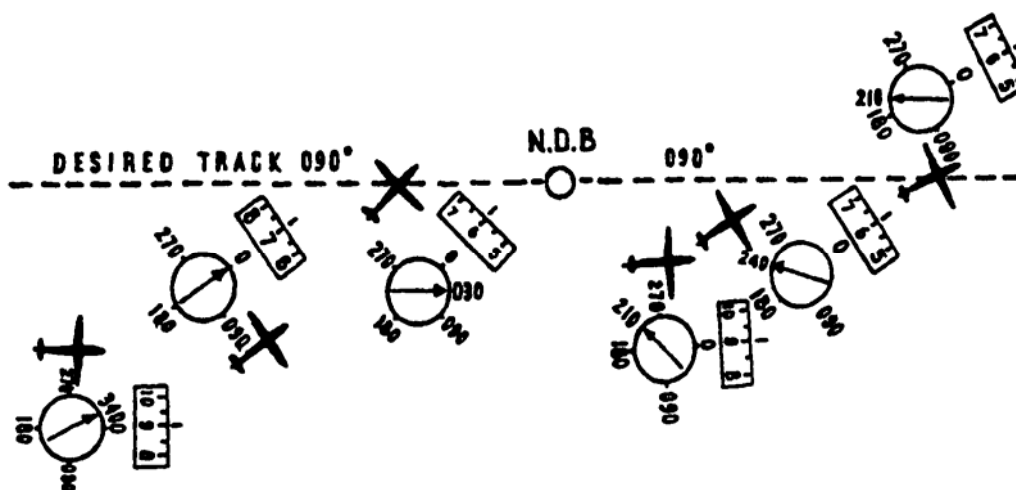

Figure 9: Intercepting and Tracking on a Given Track